



**STAVIAN**<sup>®</sup>  
INDUSTRIAL METAL

Empowering Industries,  
Enhancing Lives



# CONTENTS

COMPANY OVERVIEW **1**

OUR UNIQUE VALUE PROPOSITION **2**

PRODUCT PORTFOLIO **3**

STRATEGIC PARTNERS **4**

CORPORATE SOCIAL RESPONSIBILITIES **5**



The background image shows two construction workers in profile, facing each other. They are wearing white hard hats, safety glasses, and high-visibility yellow safety vests over grey long-sleeved shirts. The worker on the right is holding a tablet computer. The scene is dimly lit, with a strong blue-green color cast. On the left side of the image, there is a decorative graphic consisting of several overlapping white lines forming a diamond or grid pattern.

## COMPANY OVERVIEW

## Stavian Industrial Metal – A member of Stavian Group

Stavian Industrial Metal Joint Stock Company (abbr. “Stavian Industrial Metal”) is proud to be a member of Stavian Group - a multi-national industrial company with many outstanding achievements.



## Stavian Group – A multi-national industrial company

Founded in  
**2009**

Revenue  
**2 billion USD (2022)**

Customer network  
**>= 14,000 local & international customers partners**

Market presence  
**>= 100 countries & territories**



### Products & Services

  
**Chemicals & petrochemicals**

  
**Paper**

  
**High-tech material**

  
**Logistics**

  
**Recycling & circular economy**

  
**Industrial park development**

  
**Venture capital**

  
**Industrial metal**

**Awards & recognition of Stavian Group and its subsidiaries**



01

Stavian Group was named in the **TOP 10 of Vietnam Excellent Brand Awards 2022** in Processing – Manufacturing Category



02

Stavian Group was awarded **“Asia’s Best Place to Work in 2022”** by the HR Asia Magazine



03

Stavian Chemical - The Group’s major subsidiary received the **“Corporate Excellence Award 2022”** at the Asia Pacific Enterprise Awards (APEA).



04

**RANKED 22**

ICIS TOP 100 CHEMICAL DISTRIBUTORS (2021)

YOUR PROSPERITY JOURNEY STARTS WITH US.

04

Stavian Chemical ranked **#22 of ICIS’s Top 100 Largest Chemical Distributors Globally** in 2021 & **#6 in the Asia Pacific Region**

05

LỄ CÔNG BỐ TOP 500 DOANH NGHIỆP LỚN NHẤT VIỆT NAM NĂM 2021



CÔNG TY CỔ PHẦN STAVIAN HÓA CHẤT

05

Stavian Chemical ranked **#23 in the Largest Private Enterprises** in Vietnam 2022 (VNR500)

## About Stavian Industrial Metal

### Vision

To become one of Southeast Asia's TOP 10 largest industrial metal companies, contributing to promoting prosperous and sustainable development for the global industry.

### Mission

Creating utmost values for customers, shareholders, personnel, the community and natural environment through sustainable business.

### Products & Services

Trading and distribution of industrial metal materials, including: Iron ore; Steel billet; Hot rolled steel; Cold rolled steel; Construction steel; Alumina; Aluminum Ingot; Aluminum Billet; Aluminum Profile.

Stavian Industrial Metal expects to gradually expand and participate in manufacturing and processing to meet market demands.



### Business philosophy

- Customer centricity is not only our business strategy but also part of our culture, together with integrity, intelligence and outstanding service quality.
- We do not aim for growth, we aim for sustainable growth. By creating a comprehensive ecosystem, we create utmost values to our stakeholders, our employees, every community where we operate across the world and last but not the least - the global natural environment.
- At Stavian Industrial Metal, we strive towards the goal of "Shaping Life".

### Core values

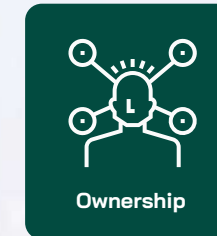

Ownership

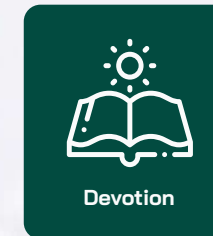

Devotion



Ingenuity



Integrity

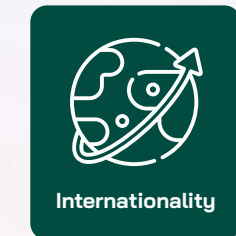

Internationality

## Board of directors



### Mr. Nguyen Minh Tu

Chairman

- One of the founding shareholders, Mr. Nguyen Minh Tu currently serves as the Vice Chairman of the Board of Directors of Stavian Group. Prior to this role, he was the CEO of A Chau Plastic Company (2002 - 2009) and a key personnel at VINAMOTOR (2002 - 2008).
- With over 20 years of experiences as senior executive leader across industries, Mr. Nguyen Minh Tu has showcased his excellent leadership when his corporates – including Stavian Chemical and Stavian Group – have achieved impressive business performance, both locally and internationally. He has been awarded Outstanding Businessman and Excellent Leader prizes for many consecutive years by the Government and Ministries.
- Mr. Tu has a broad and strong professional network in various fields including Trade, Finance, Banking, Construction Materials, Real Estate, M&A, and more.
- He holds an MBA degree from the International Business University of Scandinavia.



### Mrs. Doan Thi Trang

Director of Human Resources

- Mrs. Doan Thi Trang has over 12 years of experience in the Human Resources and Administration field and is a senior-level administrator in Human Resources and Administration at enterprises in the real estate and construction materials sectors.
- She is an expert in building and implementing short-term and long-term human resource strategies, creating a corporate culture, fostering a humane work environment, attracting, recruiting, training, and developing teams.
- The positions held by Ms. Trang as Director of Human Resources at various organizations have all contributed to their establishment of unique and distinctive corporate cultures.
- She graduated from the National Economics University.



### Mrs. Nguyen Thi Le Hoa

Chief Financial Officer

- Ms. Nguyen Thi Le Hoa has nearly 15 years of experience in the field of finance and accounting, holding positions such as Finance Director and Chief Accountant for numerous large-scale enterprises across various sectors including healthcare, construction, commerce, manufacturing, import-export, logistics, and more.
- She has held several key management positions within the Stavian Group for many years and has been recognized with numerous prestigious awards for her outstanding contributions to the Group.
- She is an expert in corporate finance analysis, overall financial planning, financial risk management and control. She holds a Professional Financial Director certificate.

## Working environment

Inheriting Stavian Group's strategy "Stavian - Happy Human Resources", we have created a working environment where the concept of Human Resources (HR) is redefined as "Happy Relationships."

"At Stavian Industrial Metal, we offer you more than just a job; we offer you a career."



*"At Stavian Industrial Metal,  
we offer you more than just a job;  
we offer you a career"*



A man in a light-colored shirt and glasses is looking down at a document he is holding. The background is a dark teal color with a grid pattern. A line graph with several peaks and valleys is overlaid on the right side of the image. The text 'OUR UNIQUE VALUE PROPOSITION' is written in white, bold, uppercase letters on the left side of the image.

**OUR UNIQUE VALUE  
PROPOSITION**

## Supply chain diagram

With a seamless international operation and 15 outstanding business solutions, we are committed to delivering comprehensive solutions to our customers and partners with optimal quality.



We're bridging industrial metal material suppliers worldwide with thousands of businesses across various industries in Vietnam and abroad:

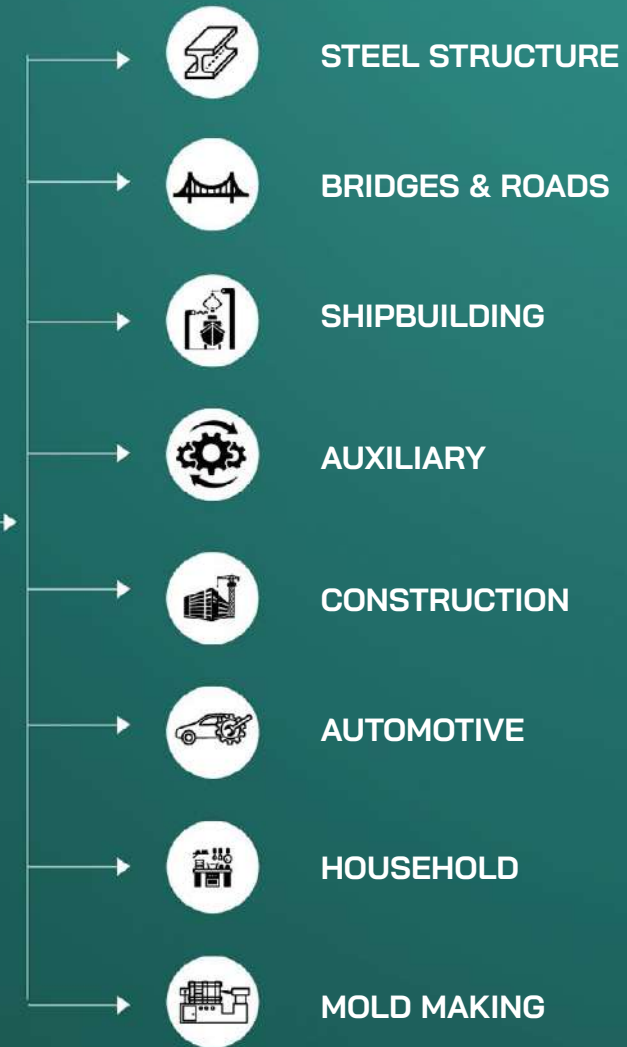

## 4 comprehensive business models

We have developed 4 comprehensive business models to enhance the company's competitive advantages and capability to meet supply and trade needs for customers, including

- (i) *Buy locally - sell locally*
- (ii) *Buy locally - sell internationally*
- (iii) *Buy internationally - sell locally*
- (iv) *Buy internationally - sell internationally*

**04**  
COMPREHENSIVE BUSINESS MODELS



## Global distribution network

- We have built a swift and effective domestic distribution network through a system of warehouses and offices in Hanoi, Hai Phong and Ho Chi Minh City.
- Additionally, inheriting reliable cooperative relationships with partners in over 100 countries and territories where Stavian Group operates, we are confident in our ability to best meet the needs of both domestic and international customers.
- With the advantage of our network and the international trade experiences of our key personnel, Stavian Industrial Metal is increasingly asserting its position as a large-scale industrial metal trading company. We not only excel in serving the Stavian Group's ecosystem but also possess full capacity to supply materials for large enterprises in the industrial sector, both domestically and internationally.





# 15

## OUTSTANDING BUSINESS SOLUTIONS

With a customer needs-oriented philosophy, we deeply understand the challenges our customers face in their operations and activities both domestically and internationally. This is why we continuously develop business solutions aimed at maximizing support for all customer requirements.

- 1 |  Spot shipment at good price
- 2 |  Import cargo – signing contracts with overseas branches of SIM
- 3 |  Formula price – Term contract
- 4 |  Offtake principle contract
- 5 |  Domestic cargo 6-month deferred payment after delivery
- 6 |  On-spot import/export
- 7 |  Co-investment contract
- 8 |  Supply raw materials  
Guarantee sales of finished products
- 9 |  Purchase material with installment payment
- 10 |  Purchase with open credit
- 11 |  Purchase with credit card
- 12 |  Purchase with credit over-draft
- 13 |  Purchase with deferred payment in VND, get preferential interest rate in USD
- 14 |  Entrusted export/import
- 15 |  All-in Logistics services

# PRODUCT PORTFOLIO

Stavian Industrial Metal offers a diverse portfolio of high-quality industrial metal products. We are committed to providing customers with premium quality products, meeting both Vietnam's and international standards, along with dedicated and exceptional customer service.



1. Iron ore



2. Steel billet



3. Hot rolled steel



4. Cold rolled steel



5. Construction steel



6. Alumina



7. Aluminum ingot



8. Aluminum billet

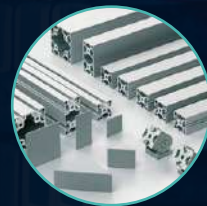

9. Aluminum Profile

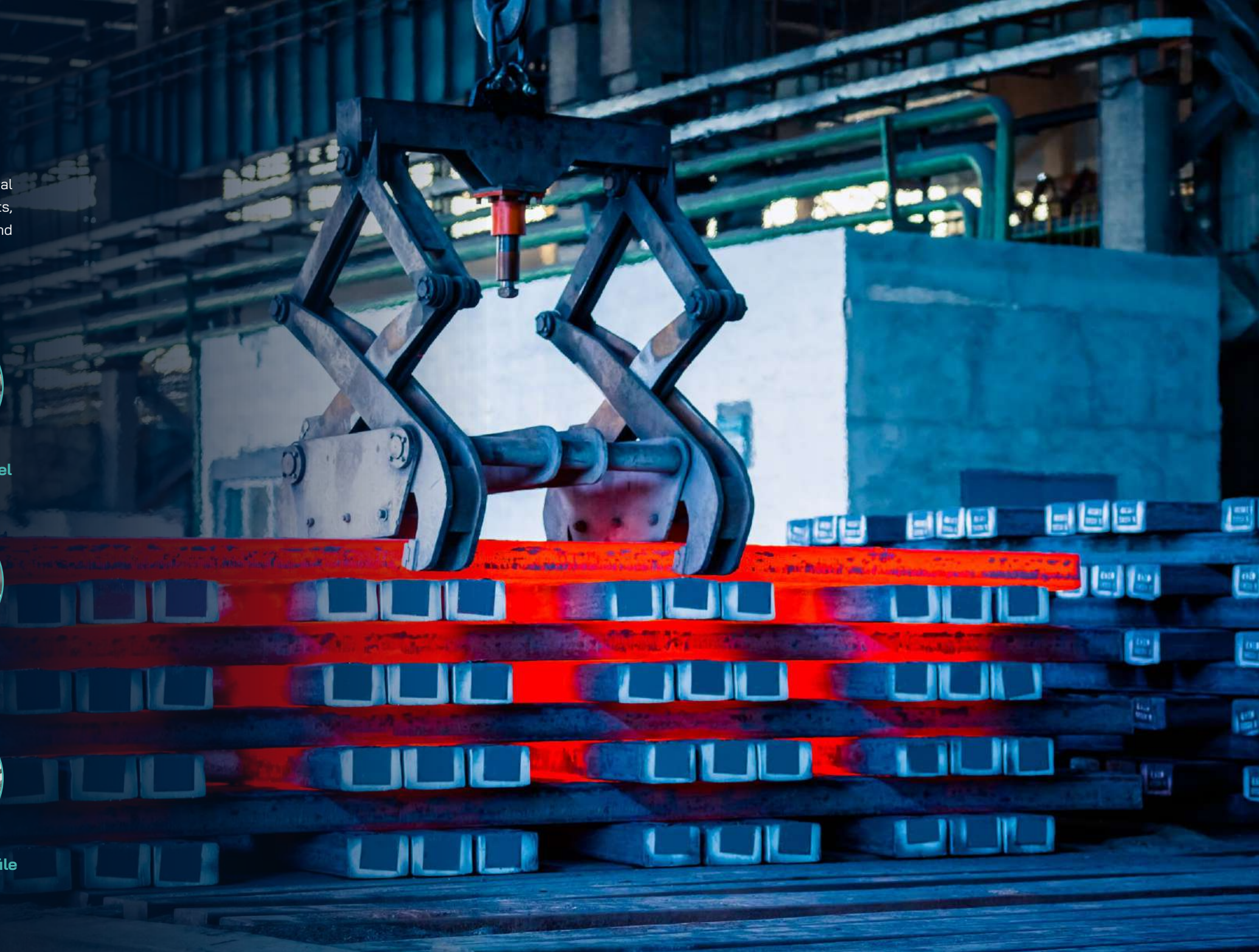

## 1. IRON ORE

Iron ore distributed by Stavian Industrial Metal is carefully tested and certified by SGS. We also provide transparent origins for our products.

In addition to quality commitment, our company is also committed to abundant reserves, output and infrastructure to ensure uninterrupted trading activities.

CATEGORIES	DETAILS
<b>Origin</b>	Southeast Asia Region
<b>Size</b>	Fine size: 0.15 – 6.3mm Lump size: 6.3 – 40.0mm
<b>Chemical Composition</b>	<ul style="list-style-type: none"> <li>• Fe: 60.0 – 68.0%</li> <li>• SiO<sub>2</sub> ≤ 4.5%</li> <li>• Al<sub>2</sub>O<sub>3</sub> ≤ 2.5%</li> <li>• P ≤ 0.15%</li> <li>• S ≤ 0.07%</li> <li>• Moisture &lt; 4.0%</li> <li>• Microelement: specified upon request</li> </ul>



## 2. STEEL BILLET

Steel billets distributed by Stavian Industrial Metal are manufactured in large-scale factories, invested in building a closed and synchronous production complex to create a continuous chain in the production of billets and finished steel.

We supply a variety of steel billets, produced by IF, EAF, and BF technology, meeting customers' requirements. Especially, customized products in large quantities are available upon customers' request.

CATEGORIES	DETAILS
Size	<ul style="list-style-type: none"><li>Nominal size: 120×120mm, 130×130mm, 150×150mm</li><li>Length: 6/12m</li></ul>
Grade	3SP, 5SP, SD295(A)...
Standard	JIS, ASTM, BS, TCVN...





### 3. HOT ROLLED STEEL

Stavian Industrial Metal provides a full range of hot rolled steel products in coils, plates and a full range of common steel grades.

The products provided by Stavian Industrial Metal are manufactured by prestigious global steelmakers such as Hoa Phat, Formosa, TATA Steel, Nippon Steel, Hyundai Steel, Baotou Steel, Shangchen Steel...

CATEGORIES	DETAILS
Coil	3 - 16mm in thickness
Plate	3 - 40mm in thickness and cut-to-order
Grade	SS400, Q345B, A36, Q235B, Q355B, A572, 1004...
Standard	JIS, ASTM, SAE, TIS, EN, MS, GB...



#### 4. COLD ROLLED STEEL

Stavian Industrial Metal provides a full range of cold rolled steel products in coils, plates, SPHC, SPCC...

Besides, we also supply sheet & coil products in prime and secondary grades from big producers around the world such as Hyundai Steel, Nippon Steel...

CATEGORIES	DETAILS
Coil	0.2 - 6mm in thickness
Plate	Cut-to-order
Type	Cold rolled coil (CR), galvanized coil (CG), electromagnetic coil (ES), oil coated coil (PO), 2 grade steel plates and coil...
Standard	JIS, ASTM, EN, JFS, AS...



## 5. CONSTRUCTION STEEL

### 5.1 Wire rod

Stavian Industrial Metal, JSC is a leading distributor of all kinds of wire rod, which are applied in the manufacturing, transportation and civil engineering industries.

CATEGORIES	DETAILS
Diameter of rod	ø6 – ø20
Diameter of steel bundle	D = 1,2m
Weight of steel bundle	W = 2000 kg
Surface	Glossy, no cracks
Color	Blue Grey
Section	Round section, the small oval
Grade	SAE 1006, SAE 1008, CB 240, CB 300...
Standard	JIS, ASTM, EN, JFS, AS...

## 5. CONSTRUCTION STEEL

### 5.2 Rebar steel

All rebar products provided by Stavian Industrial Metal have transparent origins and quality assurance in accordance with the technical standards of reputable manufacturing plants in Vietnam and worldwide.

CATEGORIES	DETAILS
<b>Grade</b>	SD295, SD390, SD490, CB300-V, CB400-V, CB500-V, Gr60, Grade 460...
<b>Diameter</b>	D06 – D50mm
<b>Application</b>	In the construction of concrete, reinforced concrete, civil houses, industrial buildings, office buildings, bridges and roads, hydroelectric projects...
<b>Standard</b>	BS, ASTM, JIS...

## 5. CONSTRUCTION STEEL

### 5.3 Section steel

Stavian Industrial Metal provides a full range of section steel including H beam, equal-leg angles from famous factories like POSCO YAMATO, TISCO, An Khanh Steel...

The products are produced on State-of-the-art production lines according to international standards such as JIS G3192:2014, KS D3502:2021, ASTM A6-11, BS 4-1:2005, EN 10365:2017...

CATEGORIES	DETAILS
Type	Thép hình H, U, I, W, thép góc...
Standard	JIS, ASTM, KS, BS, EU...
Grade	SS400, SS490, A36, A572...



## 6. ALUMINA

Alumina, commonly known as aluminum oxide  $Al_2O_3$ , is extracted from bauxite ores in tropical and subtropical regions. It is used in the production of aluminum – a metal slated for significant growth in the advancement toward a low-carbon economy.

The alumina distributed by Stavian Industrial Metal is extracted and refined using the Bayer process, meeting international standards.

CATEGORIES	DETAILS
Origin	Vietnam
Grain size	<45 micron: 12% max.
	>150 micron: 10% max.
Chemical composition	$Al_2O_3$ content: 98.5% up to 98.78%
	Impurities: specified upon request.



## 7. ALUMINUM INGOT

Stavian Industrial Metal provides high-quality aluminum ingots which are raw materials for the production of aluminum alloys (aluminum billet) and final aluminum profiles.

All products offered by Stavian Industrial Metal are well-sourced and trusted by domestic and foreign markets.

CATEGORIES	DETAILS
<b>Grade</b>	<ul style="list-style-type: none"> <li>Al 99.90/ Al 99.85/ Al 99.70/ Al 99.60/ etc</li> <li>Al 99%-99.9% min.</li> <li>Others: Al 96 or ADC-6, ADC-12/A-413, A-360...</li> </ul>
<b>Appearance &amp; Weight</b>	Silvery white, ~ 20kg-25kg or according to other standards of each manufacturer.



## 8. ALUMINUM BILLET

Stavian Industrial Metal provides aluminum billets of various types, serving the aluminum extrusion industry.

Our products are manufactured in large and reputable factories, meeting technical standards and are eligible for export.

Depending on customer requirements, billet products are cut to length or molded to many diameter sizes.

CATEGORIES	DETAILS
<b>Grade</b>	Aluminum alloy 6005, 6063, 6061...
<b>Diameter</b>	89mm, 120 mm, 127 mm, 152 mm, 178 mm, 202 mm ...
<b>Application</b>	Aluminum billets are input materials for aluminum extrusion, casting plants,... the final products are widely used in construction, architecture and mechanical industry.
<b>Standard</b>	BS, ASTM, JIS...





## 9. ALUMINUM PROFILE

Stavian Industrial Metal supplies a diversified range of aluminum products which are applied in a variety of industries, such as: Architecture & Furniture, Solar, Thermal Solution,... due to their outstanding characteristics such as lightweight & durable, high aesthetic, non magnetic and non toxic, non magnetic and non toxic, multi forms & colors and recyclable.

Stavian Industrial Metal provides OEM/ODM services, customized design upon customers' requirements at a competitive cost and in high volume.

CATEGORIES	DETAILS
Surface Treatment	Powder coating, anodizing ...
Processing services	Cutting, drilling, punching ...
Alloy series	6005, 6063, 6061 ...
Quality Standard	JIS, EN, ASTM...
Quality Management System	ISO 9001:2015, ISO 14001:2015, ISO 45001:2018...

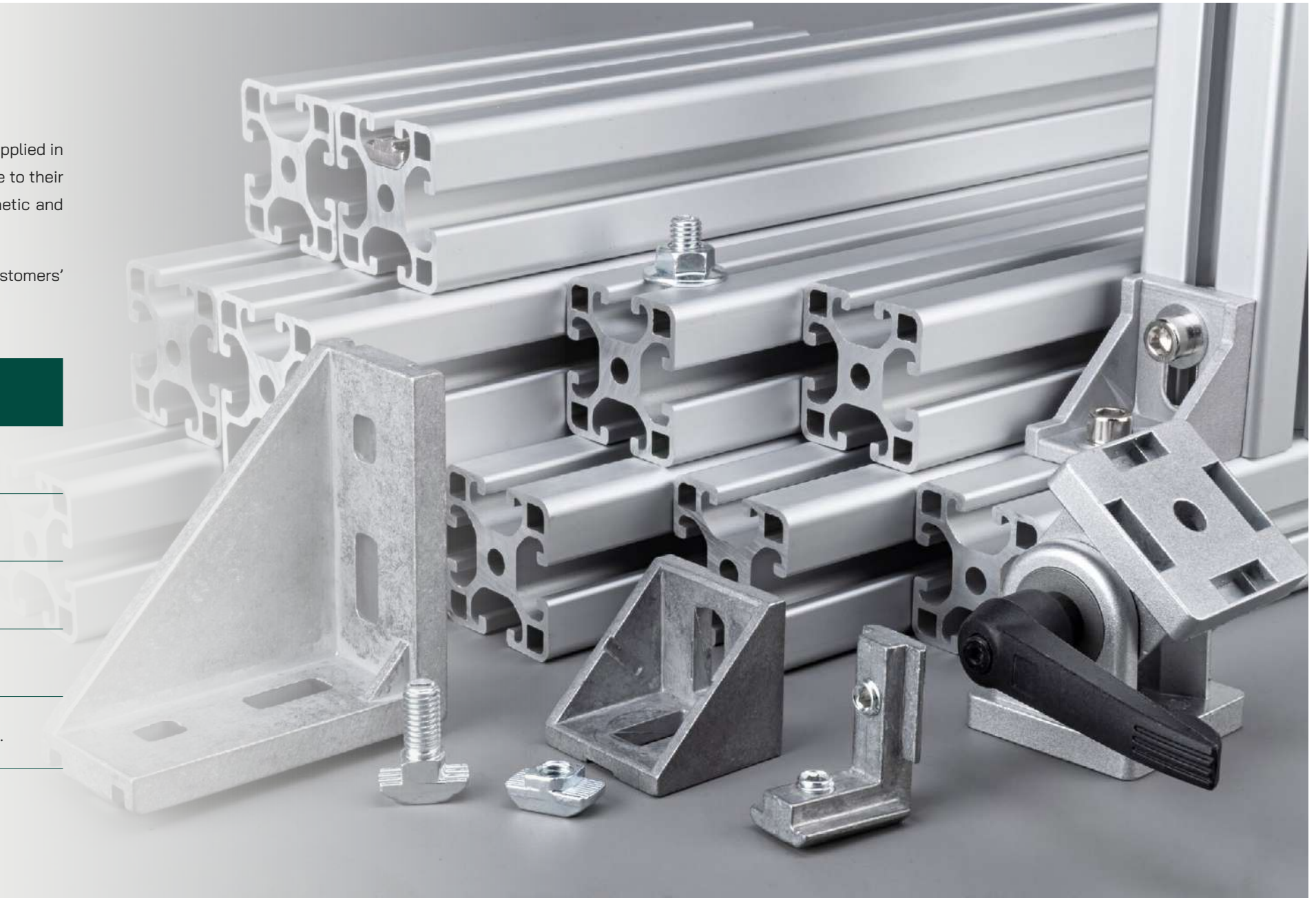



*Technical experts supervise and inspect product quality*



*Our first export batch to the international market*

A background image showing a business meeting. In the foreground, two hands are shaking in a firm grip. In the background, a person is holding a tablet computer. On the table, there are several documents with charts and graphs. The overall scene is professional and collaborative.

## STRATEGIC PARTNERS

We establish strategic and long-term relationships with financial partners, suppliers, and customers to jointly create sustainable values for the development of Vietnam's industry and economy, as well as for the region and the international community.



Suppliers



Customers



Financial partners



A close-up photograph of a person's hand holding a small, vibrant green seedling with four leaves. The seedling is growing in a dark, rich soil contained within a biodegradable, light-colored pot. The background is softly blurred, showing more of the hand and the natural setting.

## CORPORATE SOCIAL RESPONSIBILITIES

---

We understand and continuously improve the quality of our CSR initiatives, with the commitment to pay it forward.

# Corporate Social Responsibilities



## Business

- Excellent business performance
- Satisfied customers
- Management and compliance

## Environment

- Environmental care
- Supporting customers in achieving environmental goals

## Society

- Diverse development, health and safety training
- Equal development opportunities





Building schools for children in highland areas



• Visiting, encouraging and donating meaningful gifts to the Nho Quan Rehabilitation Center for Veterans



Providing prosthetic limbs to elderly individuals in poor conditions in Ninh Binh







Sponsoring reforestation and environmental improvement projects in highland regions



STAVIAN CHEMICAL – Diamond sponsor of SEA Games 31

## Contact information

### BUSINESS NAME

STAVIAN INDUSTRIAL METAL.,JSC

### HEADQUARTERS

No.508 Truong Chinh Street, Nga Tu So Ward, Dong Da District, Hanoi City

### HAI PHONG BRANCH

6<sup>th</sup> Floor, Thanh Dat 1 Tower, No.3 Le Thanh Tong Street, May To Ward, Ngo Quyen District, Hai Phong City

### SOUTHERN BRANCH

12A<sup>th</sup> Floor, Vincom Center, No.72 Le Thanh Ton, District 1, Ho Chi Minh City

### CONTACT

Phone: +84 24 7100 1868

Email: [info@stavianmetal.com](mailto:info@stavianmetal.com)

Website: [www.stavianmetal.com](http://www.stavianmetal.com)





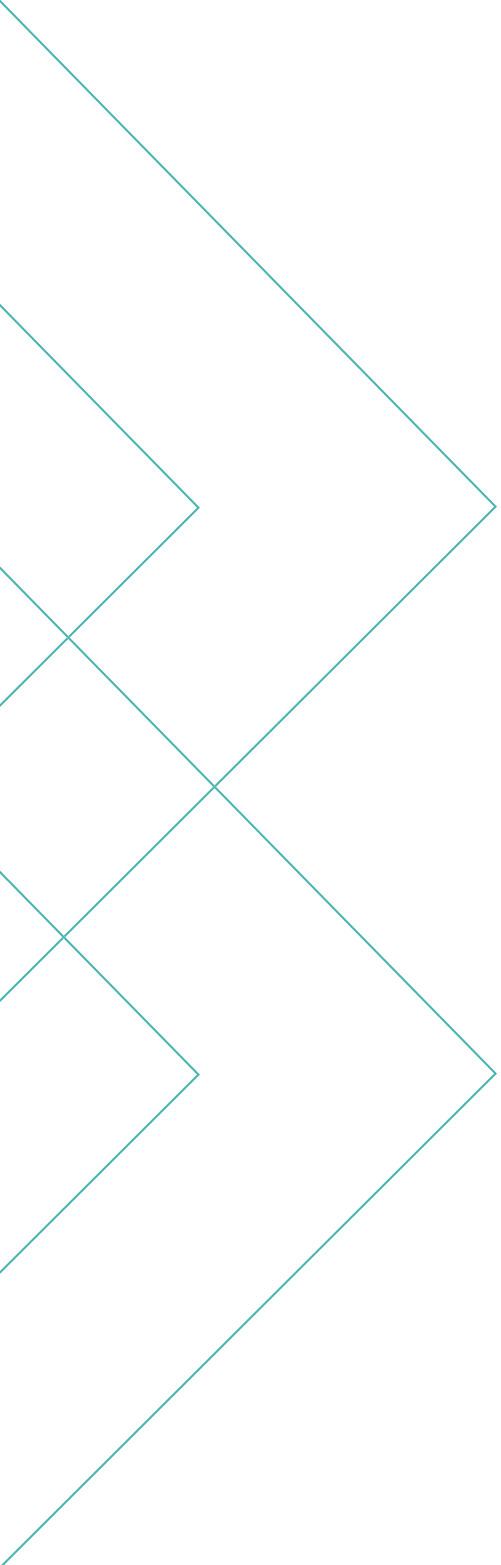

COMPANY  
PROFILE

STAVIAN  
INDUSTRIAL  
METAL

